

Gewindedrehhalter Innen AN

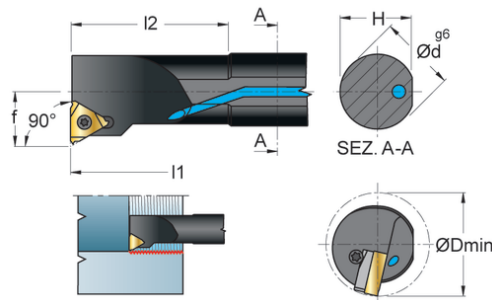







Art. Nr. 1475010



Gewindedrehhalter TYP AN
für sämtliche ISO-Gewindedrehplatten innen

Art. Nr.	Typ	ØD mm	I1	Ød mm	f mm	H mm	L2 mm	Wpl	Preis €
1475010005	ANR0010K11	12	125	16	6,6	15,3	24,65	11IR	99,00
1475010010	ANL0010K11	12	125	16	6,6	15,3	24,65	11IL	99,00
1475010015	ANR0013L11	15	140	16	8,2	15,3	32	11IR	105,00
1475010020	ANL0013L11	15	140	16	8,2	15,3	32	11IL	105,00
1475010025	ANR0016M16	19	150	16	10,6	15,3	40	16IR	111,00
1475010030	ANL0016M16	19	150	16	10,6	15,3	40	16IL	111,00
1475010035	ANR0020Q16	24	180	20	14	19,0	50	16IR	136,00
1475010040	ANL0020Q16	24	180	20	14	19,0	50	16IL	136,00
1475010045	ANR0025R16	29	200	25	16,3	24,0	55	16IR	154,00
1475010050	ANL0025R16	29	200	25	16,3	24,0	55	16IL	154,00
1475010055	ANR0032S16	36	250	32	19,6	31,0	55	16IR	184,00
1475010060	ANL0032S16	36	250	32	19,6	31,0	55	16IL	184,00
1475010065	ANR0020Q22	27	180	20	15,6	19,0	50	22IR	161,00
1475010070	ANL0020Q22	27	180	20	15,6	19,0	50	22IL	161,00
1475010075	ANR0025R22	32	200	25	17,4	24,0	60	22IR	184,00
1475010080	ANL0025R22	32	200	25	17,4	24,0	60	22IL	184,00
1475010085	ANR0032S22	39	250	32	21,5	31,0	60	22IR	221,00
1475010090	ANL0032S22	39	250	32	21,5	31,0	60	22IL	221,00

Ersatzteile Gewindehalter AN

	 		 		 		 	
	Wendeplattengröße	Artikelnr.	Typ	Artikelnr.	Typ	Artikelnr.	Typ	Artikelnr.
11IR/L bis 0013	-	-	-	-	1920005078	12254P	1920500155	5507P
16IR/L für 0016	-	-	-	-	1920005085	123511P	1920500170	5515P
16IR/L bis 0032	1920021050	U16ER	1920004035	VS16T	1920005154	S16T	1920500150	5510
	1920021051	U16IR						
22IR/L für 0020	-	-	-	-	1920005157	S22T	1920500245	5620
22IR/L ab 0025	1920021055	U22ER	1920004040	VS22T	1920005157	S22T	1920500245	5620
	1920021056	U22ER						